



# Weather Station 使用手册

## Weather Station Manual

---



LeoYan @ DFRobot

10/10/2014

**注意事项:**

**Notes:**

A. 本产品含有微小部件，不适于 6 岁及以下幼儿使用。

Micro components are included in this component kit. Please keep it away from kids under age six.

B. 本产品无防雨淋功能，请在防雨的环境下使用。

This product is not waterproof. Please keep it away from rain.

# 基础制作 Basic Installation Instructions



## 1 准备 Preparations

### 1) 气象站套件 Component Kit for the Weather Station

套件可以从 DFRobot 官网或代理商购买，套件包含如下部件/工具：

You can get the weather station component kit on our official website or from our agents.

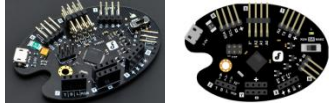
Components/Tools included in the Kit are as follows.

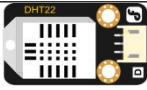
部件/工具 Components/Tools	说明 Description	数量 NO.	图示 Illustration
外壳 Case	为 3mm AA 椴木夹板激光切割件； 用于支撑和保护内部模块，并减少 阳光辐射对测量的影响 3mm AA laser-cut basswood plywood; to support & protect modules inside and reduce solar radiation's influence on measurements	1	
Palette 主控板 Palette main control panel	基于 Atmega32U4 的控制板，兼容 Arduino Leonardo。 Based on Atmega32U4; compatible to Arduino Leonardo	1	
mini 面包板 mini breadboard	面包板，用于各模块的连接 breadboard; for connection of all modules	1	
LCD 液晶模块 LCD Module	LCD 1602，用于显示信息 LCD 1602; for display information	1	
触摸传感器 Touch Sensor	显示屏开关 LCD display switch	1	
DHT22	用于测量温湿度 For measurements of temperature & humidity	1	
BMP085	用于测量大气压；其排针需要自行 焊接 For measurements of barometric pressure; You need to weld the Pin	1	

	Headers.		
时钟模块 Clock Module	钟表功能，可以获取日期和时间； 自带电池，掉电不影响计时。 Installed with battery, it functions as a clock, showing time & date.	1	
螺丝 Screws	M3x10 镀镍十字圆头带垫螺丝 M3x10 Ni-plated Pan Phillips Head Self-Tapping Screw	10	
螺母 Nuts	M3 尼龙螺母，和螺丝配合用于紧固 M3 Nylon nut; used with screws to tighten things	10	
蓝丁胶 Blu-tack	用于粘贴 Used to paste things	1	
杜邦线 Dupont Line	F/M 15-18cm 10 M/M 10-12cm 5 用于电气连接 To wire things up	1	
太阳能板 Solar Module	光合太阳能电池板多晶 6V2W，用于将太阳能转换成电能 Polycrystalline solar panels photovoltaic modules 6V2W used to transfer solar energy into electric energy	1	
太阳能配线 Solar Cables	太阳能板的引出线，需要自行焊接 Leads for the solar panel. You need to weld it on your own	1	
太阳能充电模块 Charge Module	太阳能充电模块，用于给锂电池充电 Solar charge module; used to charge the lithium battery	1	
锂电池包 Lithium Battery Pack	3.7V 1000mAh 锂电池包 3.7V 1000mAh Lithium Battery Pack		

该套件样例程序可以支持[灰尘传感器](#)，可以另外选购：

The sample program within this component kit is also compatible to dust sensor. Click [here](#) to get your own air quality sensor.

## 2) 工具 Tools:

- 美工刀 Pan Knife

DFRobot 版权所有

Copyright © DFRobot. All rights reserved. CC BY-NC 3.0 CNP a g e | 4

- 十字螺丝刀 Phillips screwdriver
- 一字螺丝刀（0号，刀头宽度为3mm）#0, 3mm Slotted screwdriver

### 3) 外壳说明 Description of the Case

外壳为椴木板激光切割而成，因此其一面会有烧灼的痕迹，这是正常现象，安装时将其用于内部即可。

The case is made of laser-cut basswood plywood. Thus, there might be some laser-burnt marks. It's normal. Just hide the burnt marks when assembling.

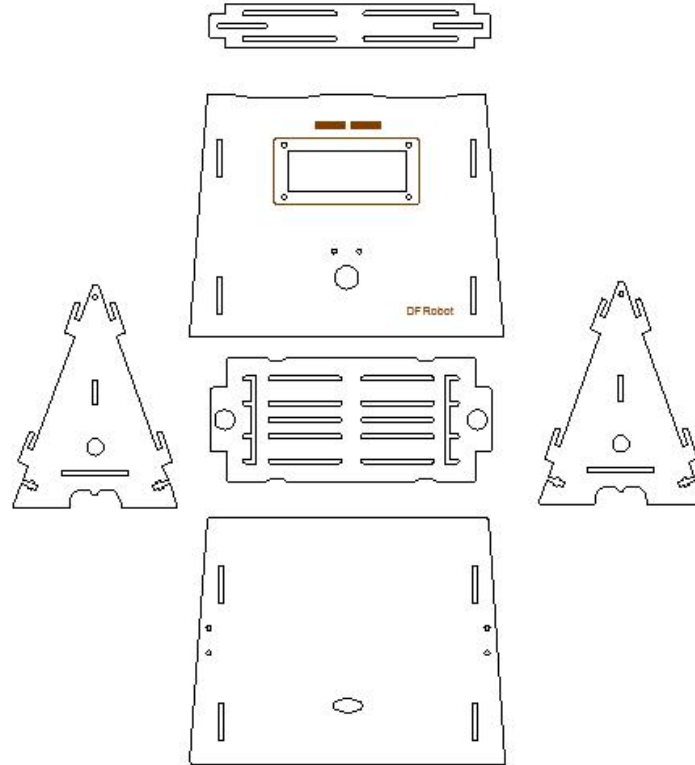

### 4) 蓝丁胶的使用 How to use the blue tack

蓝丁胶是一种压敏型胶粘材料，能反复使用，环保无害。

Blu-tack is a reusable putty-like pressure-sensitive adhesive. Also, it's harmless and environment-friendly.

粘贴方法如下：How to paste with Blu-tack

- ✓ 通过拉扯揉捏，使其充分软化，变得粘手  
Pull & twist the Blu-tack to make it soft and sticky
- ✓ 取适量揉成小球，在制作气象站时揉成 3-4mm 左右的小球即可  
Roll it into balls with 3-4mm in diameter
- ✓ 将 3 到 4 个小球放在粘贴物的表面，然后平均用力将其粘贴到被粘物上  
Place 3 or 4 Blu-tack balls on one object and then stick it to another object

取下方法是：用手指采取搓揉、卷曲的方式将“蓝丁”取下。

How to remove the Blu-tack: rub & roll it

## 2 软件安装 Installation of Software

- 1) 安装 Arduino IDE: <http://arduino.cc/en/Main/Software> (版本不低于 Arduino1.0.5)  
Install Arduino IDE: <http://arduino.cc/en/Main/Software> (The version shall at least be Arduino1.0.5.)
- 2) 安装相关库: 从 DFRobot 官网产品页下载压缩文件中获取 libraries;  
Install related libraries: find libraries from the compressed files downloaded on our website
- 3) 解压后, 将其拷贝到 Arduino/libraries/目录下  
Unzip the files and then copy and paste it to the file of Sketchbook location within the Arduino file just as it is shown below.

```
\Arduino 的程序库位置(Sketchbook location)\  
    --libraries\  
        --public  
        -- ds3231  
        -- bmp085  
        -- dht  
        -- WeatherStation
```

## 3 程序加载 Program Loading

### 1.1 设置时钟模块时间

#### Set time for the clock module

- 1) 硬件连接: 如何将实时时钟模块和主控板连接, 注意 VCC 要连接到 ICSP 区域, R 区的 VCC (+) 是需要通过程序打开才能使用。  
Hardware connection: how to connect the clock module with the main control panel.  
Notice that VCC shall be connected to the ICSP area & VCC (+) located within the R area cannot be used without the program.

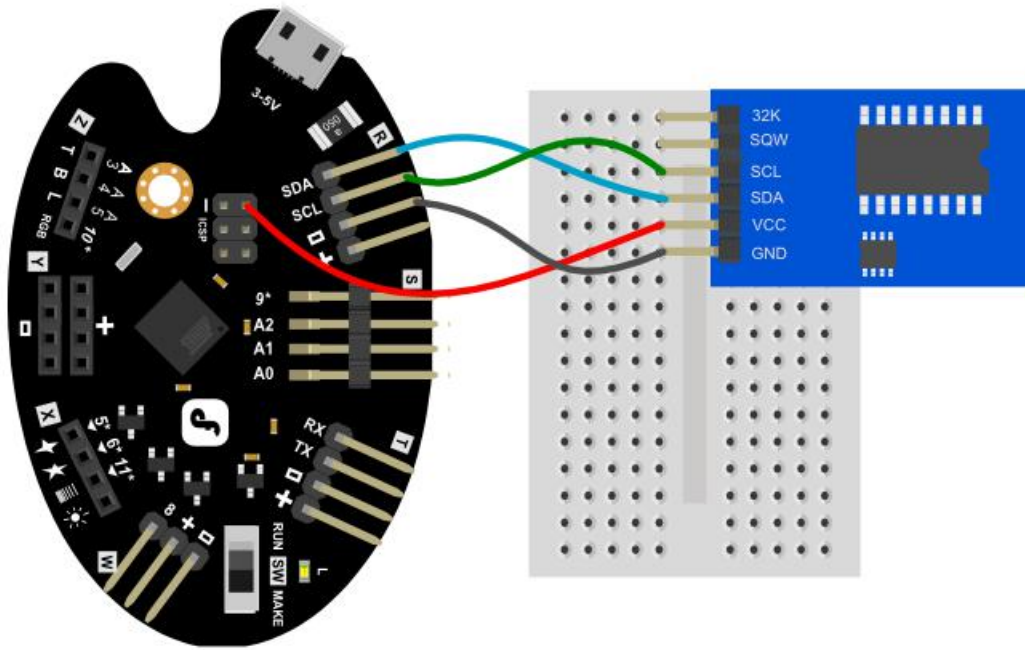

2) 打开 Arduino IDE，选择板类型为：LilyPad Arduino USB

Open Arduino IDE & the selection panel shall be LilyPad Arduino USB.

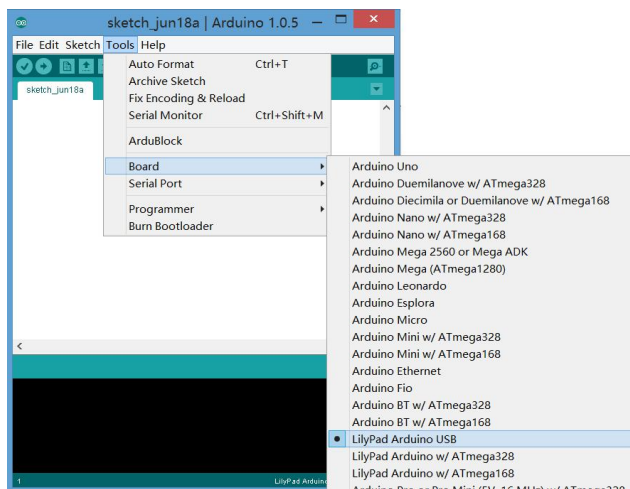

3) 打开 ds3231 中 adjust 样例程序

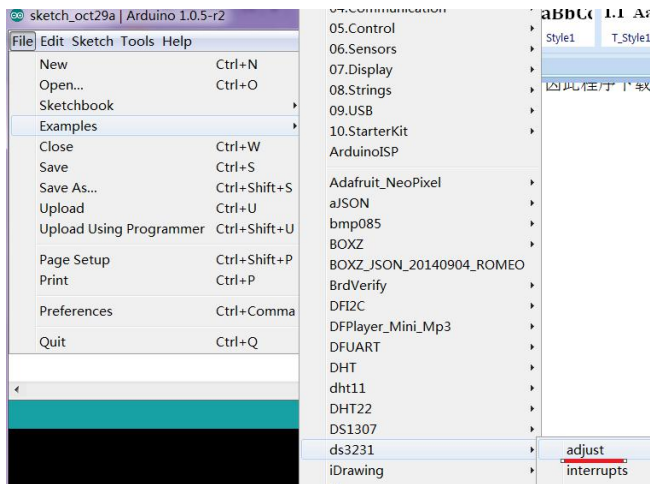

- 4) 修改 `adjust` 代码中红色部分为当前时间, 图示所示 `dt DateTime dt(2014, 8, 4, 12, 1, 0, 1)` 表示: 2014年8月4日12时1分0秒、星期1; 注意: 任何数字前不要加0, 比如使用 `08` 是不正确的。

Change the parts in red within the `adjust` code into the current time. `dt DateTime dt(2014, 8, 4, 12, 1, 0, 1)` shown in the picture below means 12:01:00 on 4 August 2014, Monday.  
 Note: No zero before any number. For instance, `08` is incorrect.

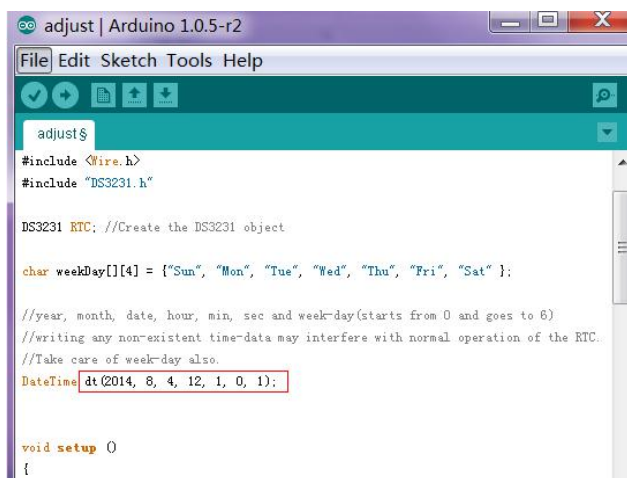

- 5) 将 4Drawing 控制板上的开关拨到“MAKE”状态  
 Turn the switch on the 4Drawing control panel to “MAKE” as it is shown below

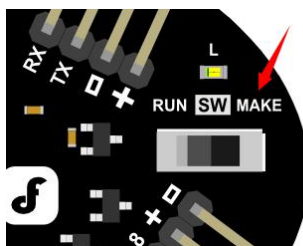

- 6) 将电脑和 4Drawing 的控制板通过 micro-USB 线缆连接



Connect your PC with the 4Drawing control with micro-USB cables

- 7) 连接后在 Arduino IDE 中将对应串口进行勾选,若没有相应串口,则需要手工安装驱动,请参考 <http://arduino.cc/en/Guide/Windows#toc4>

Check the correspondent serial port within Arduino IDE. If there is no serial port within it, you will have to install a serial port driver. Click here for reference:

<http://arduino.cc/en/Guide/Windows#toc4>

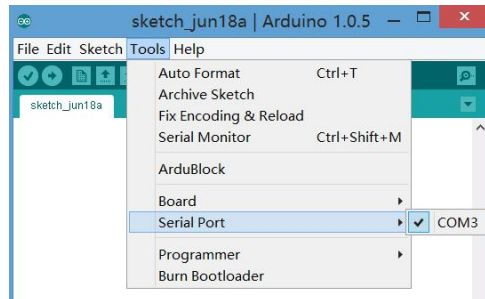

- 8) 下载 adjust 程序到控制板

Download the adjust program to the control panel



- 9) 打开 Arduino 串口, 能够看到当前的时间的显示, 则设置正确, 将 RTC 模块取下; 否则重新设置时间。

Open the Arduino serial port and you can see the time displayed on the screen. Then remove the RTC module or reset the time.

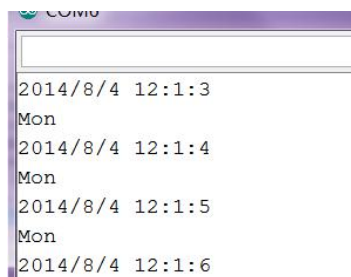

## 1.2 加载气象站程序 Load the Weather Station Program

1) 在 Arduino IDE 中打开 WeatherStation 中 example 样例程序

Open the example program under WeatherStation, which is within the Arduino IDE

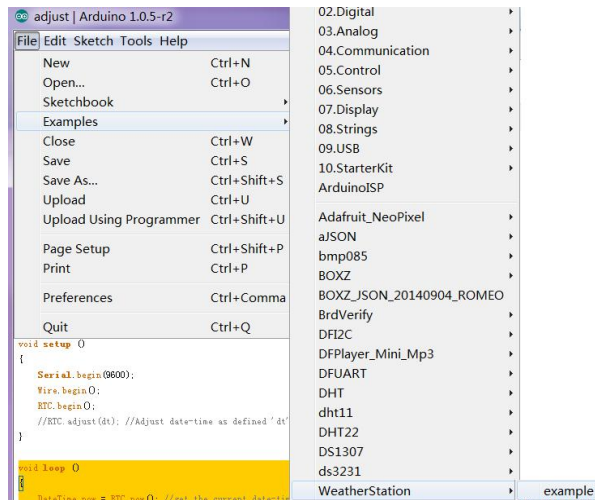

2) 将样例程序下载到主控板

Download the example program to the main control panel

3) 将 4Drawing 控制板上的开关拨到“RUN”状态

Turn the switch on the 4Drawing control panel to “RUN” as it is shown below

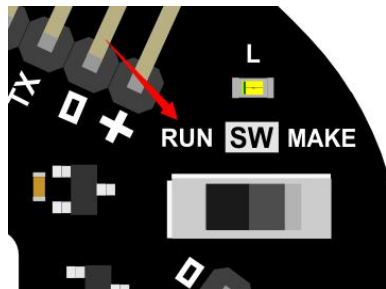

## 4 制作 Assembling

### 1.1 前板安装 Assemble the Front Plate

将触摸模块和 LCD 如图方式用固定在前面板上，并将配套线缆接入相应的模块接口。安装 LCD 时，在图中红色圆圈的地方需要 3-4 片垫片，用以保持 LCD 安装后的平整。

Fix the Touch Panel & LCD Module on the front plate just as it is shown in the photo below and slide cables into correspondent connectors of the modules. When assembling the LCD Module, place three or four spacers on the area within the red circle as it's shown in the photo below to keep the front plate even.

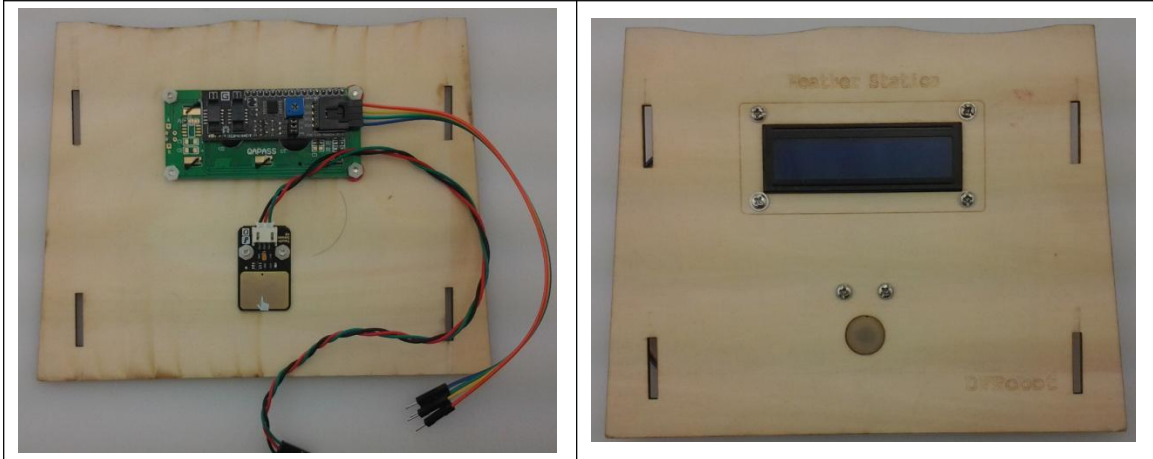

## 1.2 后板安装 (solar, charger)

### Assemble the Rear Plate

- 1) 将背板的一面粘贴上铝箔纸（铝箔纸自身带背胶），将多余的部分和孔槽处用美工刀裁掉。铝箔纸的作用是降低阳光对内部传感器的影响。

Paste aluminum paper on one side of the rear plate (aluminum paper with glue on one side) & remove the remaining part as well as the aluminum paper covering the holes in the rear plate. Aluminum paper is used to reduce the influence of sunshine on the internal sensor.

- 2) 如图将太阳能板通过蓝丁胶安装在有铝箔的一面，接线从椭圆孔中穿过。

Stick the solar panel to the side of the rear plate pasted with aluminum paper by applying Blu-tack. Then slide the cables through the oval-shaped holes in the plate.

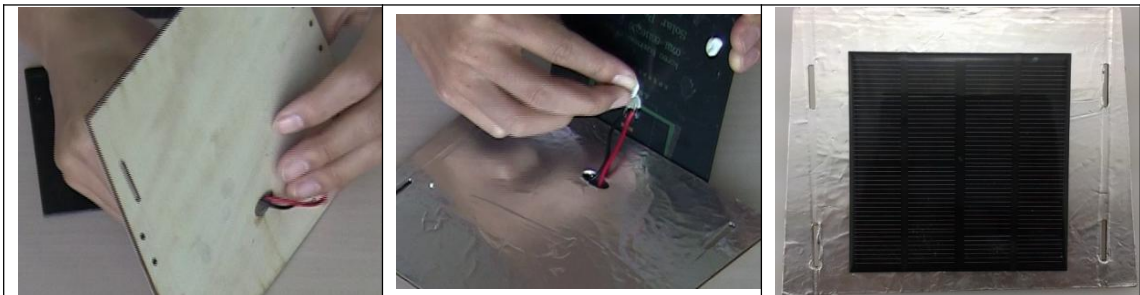

- 3) 如图将充电模块、锂电池用蓝丁胶固定在背板上；然后将线接好。

Fix the charge module & lithium battery on the rear plate with Blu-tack just as it's shown in the map below and then connect the cables properly.

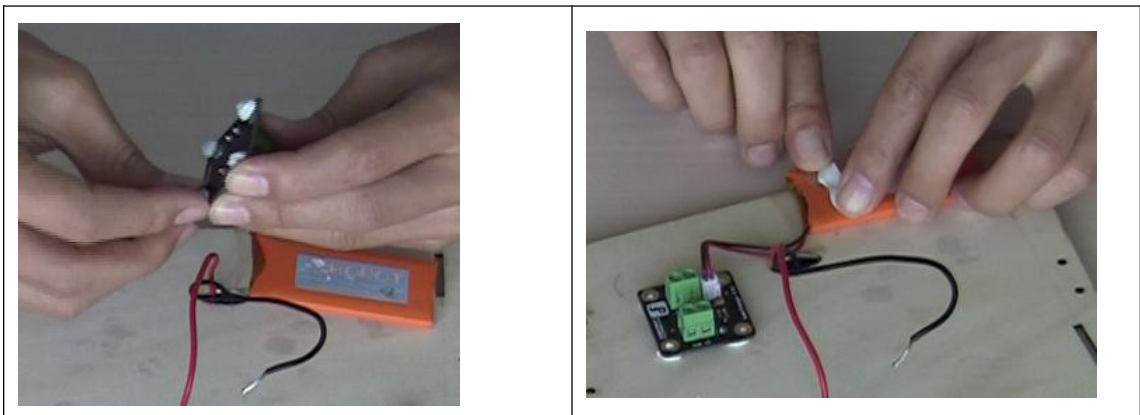

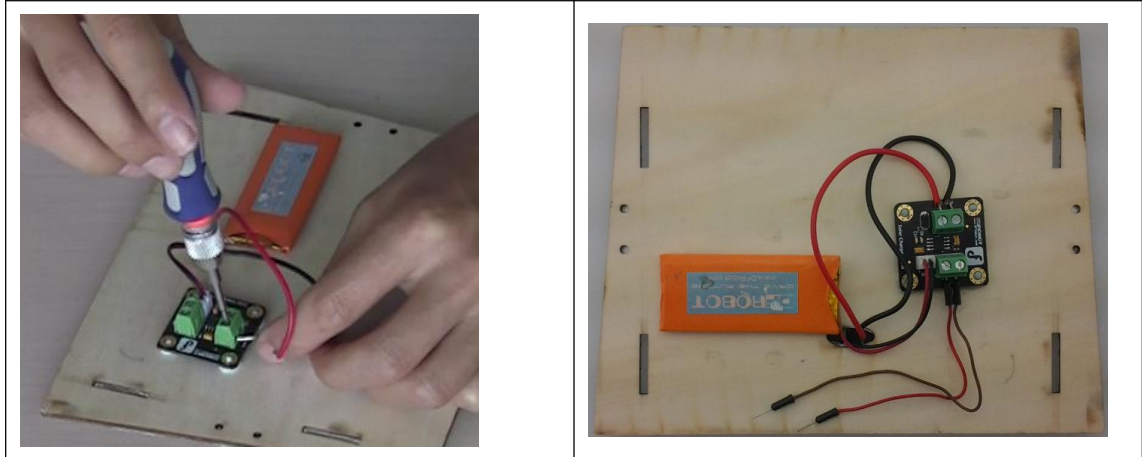

### 1.3 底板安装 Assemble the bottom plate

- 1) 将主控板和 mini 面板板用蓝丁胶固定在底板上，位置如下图。  
Fix the main control plate & mini breadboard on the bottom plate with Blu-tack. Details are shown in the photo below.

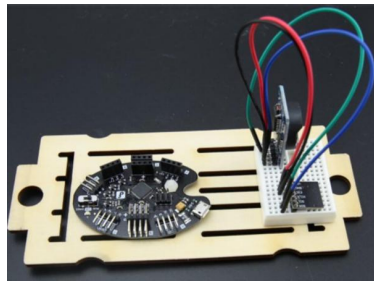

- 2) 将时钟模块（I2C 接口一侧）和气压传感器插入到面包板中，参照下图进行接线  
Slide the clock module ( the side with I2C input) and the barometric pressure sensor into the breadboard. When connecting the cables, you can refer to the map below.

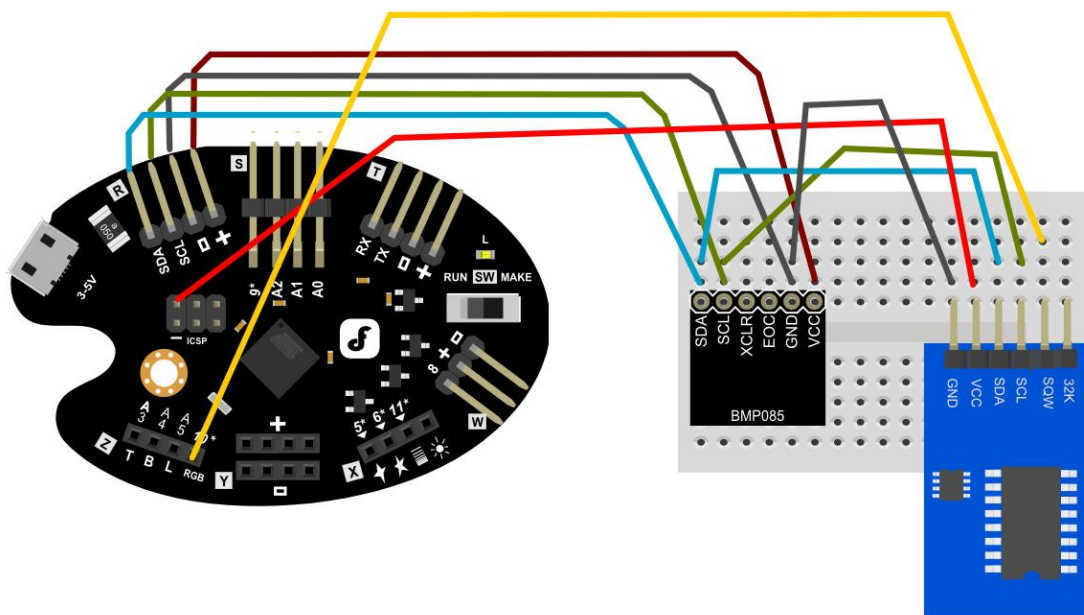

#### 1.4 横架安装 Assemble the Bar

将 DHT22 温湿度传感器如图用螺丝固定在横架上：

Fix the DHT22 temperature & humidity sensor on the bar with screws as it's shown in the photo below.

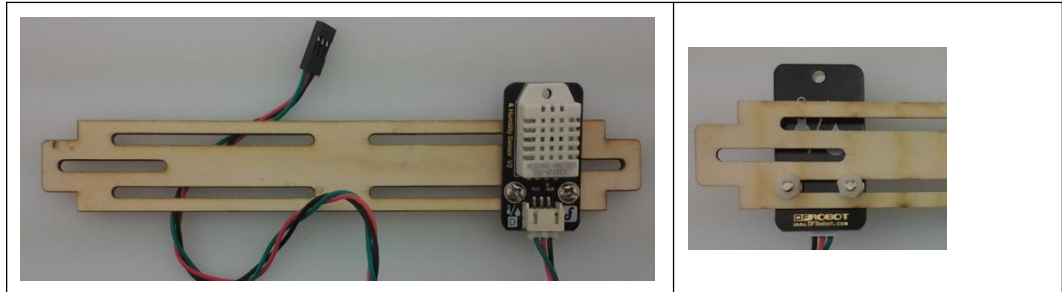

#### 1.5 侧板安装

##### Assemble the Side Plate

将螺母放入侧板底部的十字槽中，其中两个螺母将用于最后组装时连接背板。（实际组装时只用靠近背板的两个螺母，这里全部装上，是为了整体组装时方便）

Place nuts into cross-slots at the bottom of the side plate. Two of the nuts will be used to connect it with the rear plate. (Practically, we will only used the two nuts close to the rear plate. Here we slide them all into the slots to make things easy for the overall installation.)

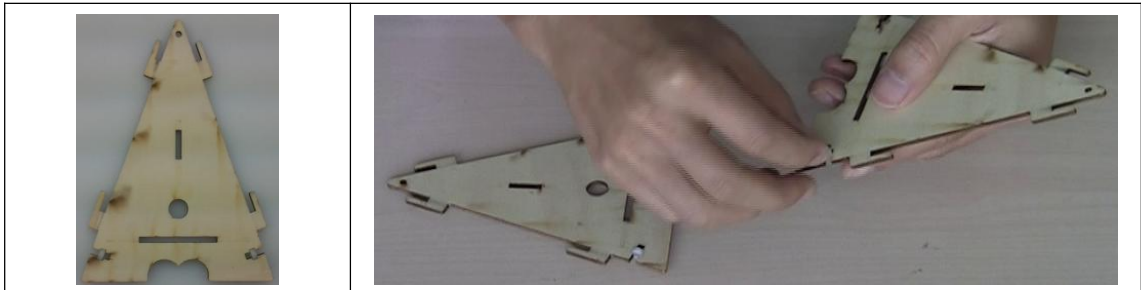

#### 1.6 整体组装 Overall Installation

- 1) 按下图将各模块连接；连接好后点击前面板的触摸模块，若有内容显示则正常，否则检查接线。

Follow the map below and connect the modules. Once connected click the touch module on the front plate and check if information is displayed properly on it. If not, check the cable connections.

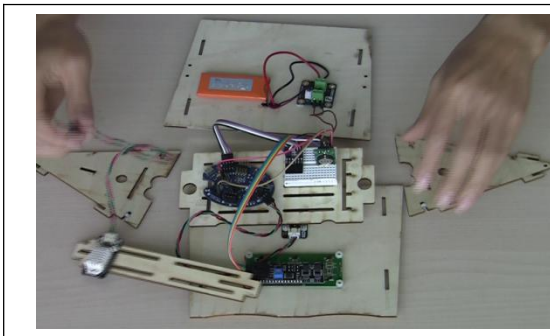
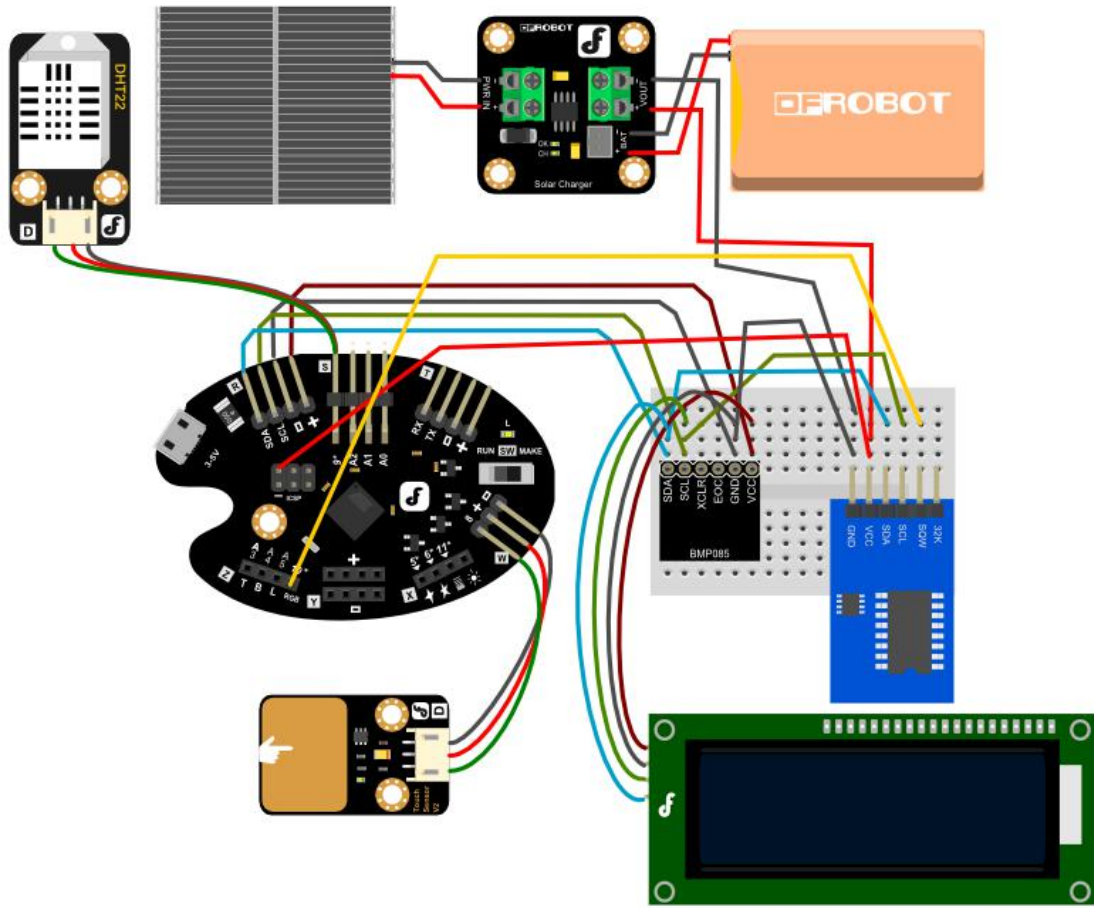

- 2) 按下图将各部件依次拼接，后面板装好后拧上两个螺丝，则组装完成。  
 Connect the components in an orderly manner as it's shown in the photo below and cover it with the rear plate. Then tighten the two screws. And the installation is done.

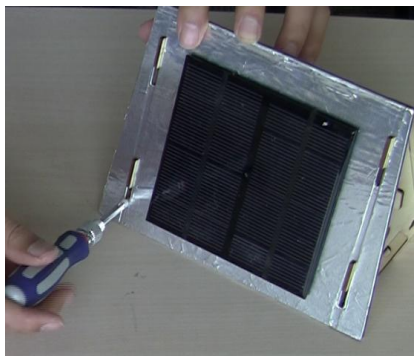
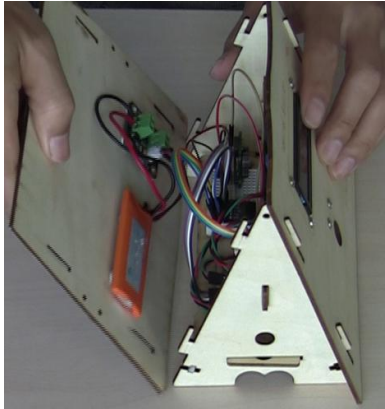
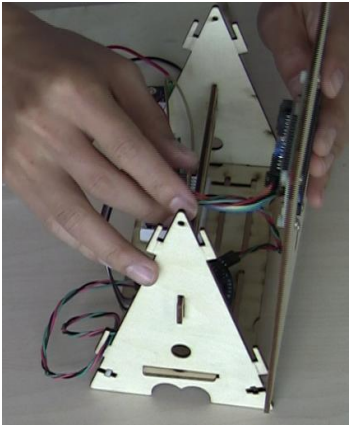
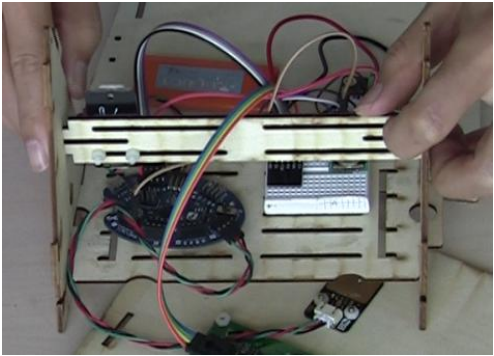
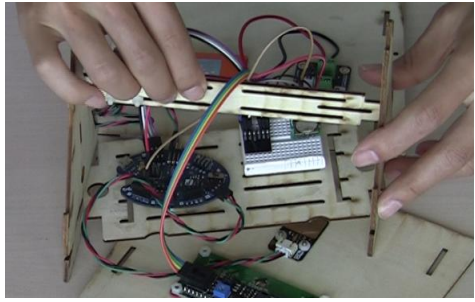
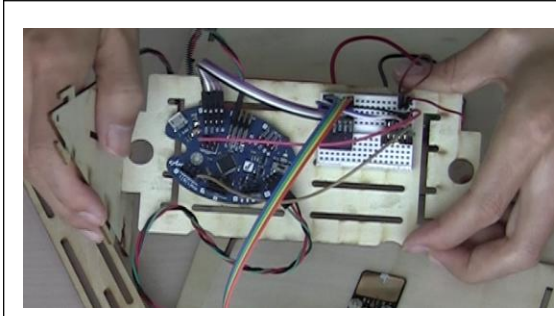

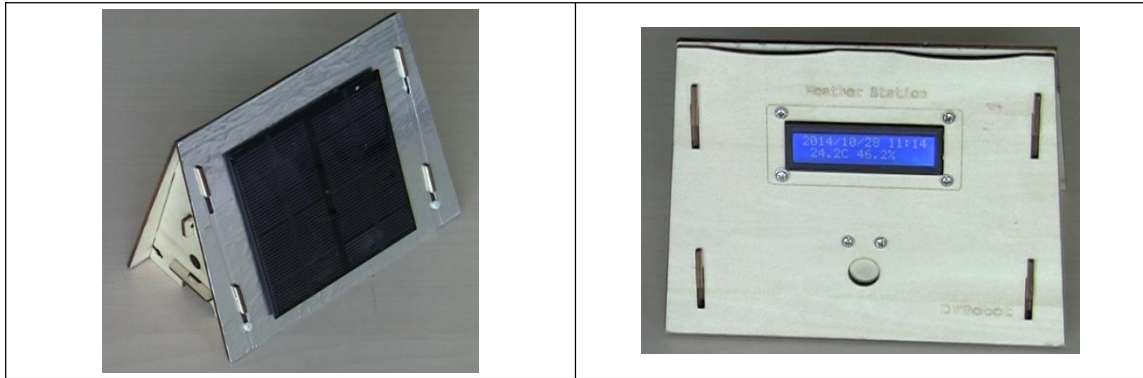

## 扩展制作

### Extension Installation Instructions

#### 5 增加空气质量检测 Air Quality Monitor Installation

##### 5.1 准备 Preparation

请购买如下模块：Please purchase the following modules.

部件/工具 Components/T ools	说明 Description	数量 NO.	图示 Illustration
空气质量传感器 Air Quality Sensor	<a href="#">Sharp GP2Y1010AU0F 空气质量传感器</a> <a href="#">Sharp GP2Y1010AU0F Air Quality Sensor</a>	1	
转接模块 Module Adapter	<a href="#">SHARP 空气质量传感器转接模块</a> <a href="#">SHARP Dust Module adapter for the Air Quality Sensor</a>	1	

##### 5.2 加载气象站程序 Load the Weather Station Program



修改 WeatherStation 的样例程序，如下图将红色箭头所指行前面的注释符号“//”去掉，这样将启动空气质量传感器。将程序下载到主控板。

Modify WeatherStation's example program. Delete "//" within the line starting with a red arrow just as it is shown in the photo below to initiate the air quality sensor. Download this program to the main control panel.

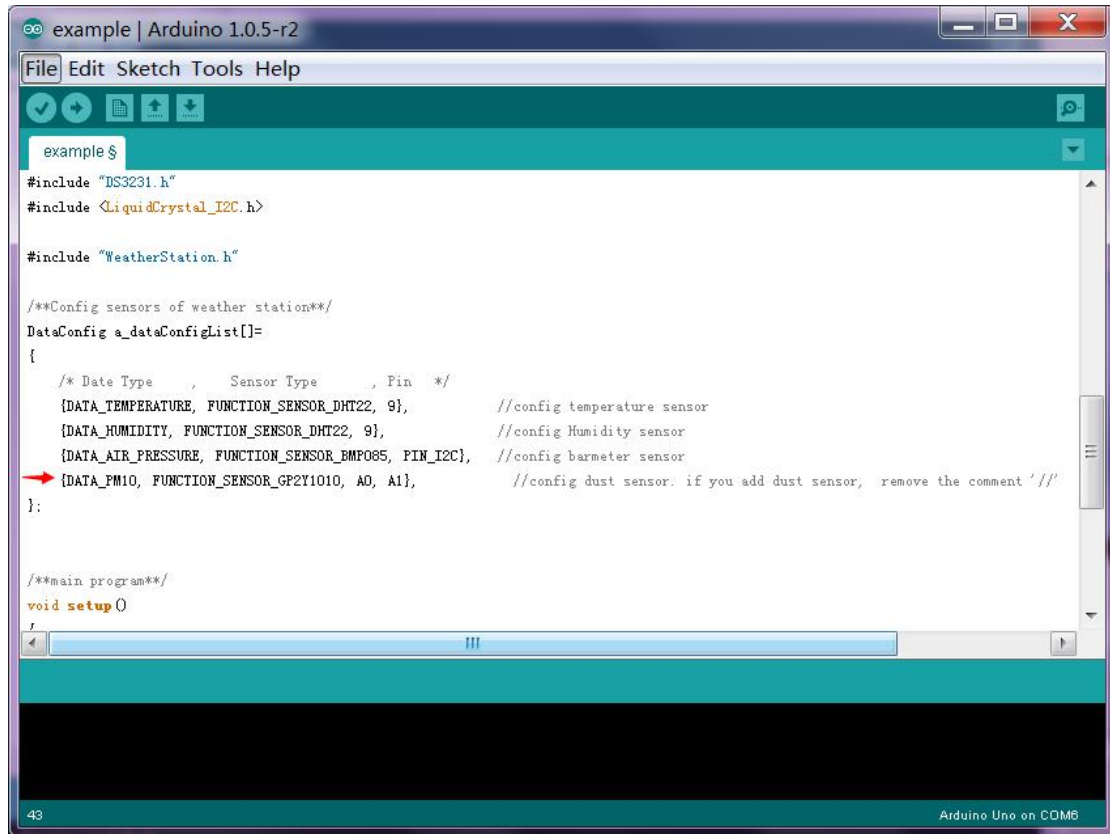

```
example | Arduino 1.0.5-r2
File Edit Sketch Tools Help
example $
#include "DS3231.h"
#include <LiquidCrystal_I2C.h>

#include "WeatherStation.h"

/**Config sensors of weather station**/
DataConfig a_dataConfigList[]=
{
  /* Date Type      Sensor Type      Pin */
  {DATA_TEMPERATURE, FUNCTION_SENSOR_DHT22, 9}, //config temperature sensor
  {DATA_HUMIDITY, FUNCTION_SENSOR_DHT22, 9}, //config Humidity sensor
  {DATA_AIR_PRESSURE, FUNCTION_SENSOR_BMP085, PIN_I2C}, //config barmeter sensor
  → {DATA_PM10, FUNCTION_SENSOR_GP2Y1010, A0, A1}, //config dust sensor: if you add dust sensor, remove the comment '//
};

/**main program**/
void setup()
{
}
}

43 Arduino Uno on COM6
```

### 5.3 制作 Assembling

如图将空气质量传感器和转接板按如下图方式进行安装和接线

Refer to the map below and connect the air quality sensor and processing panel.

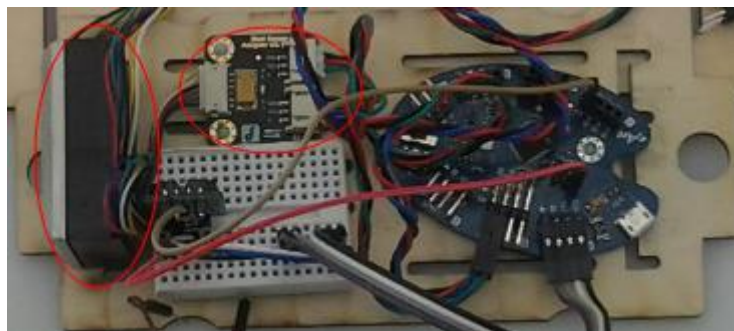

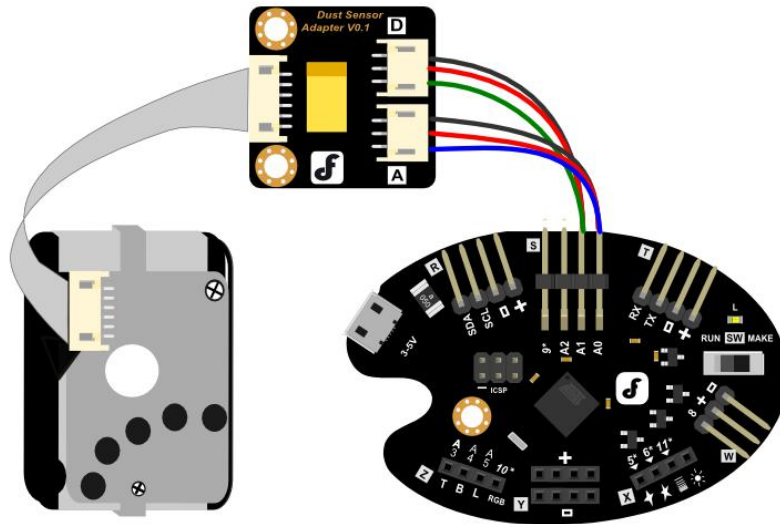

## 5.4 组装 Installation

和基础制作方式相同。

Refer to basic installation instructions.

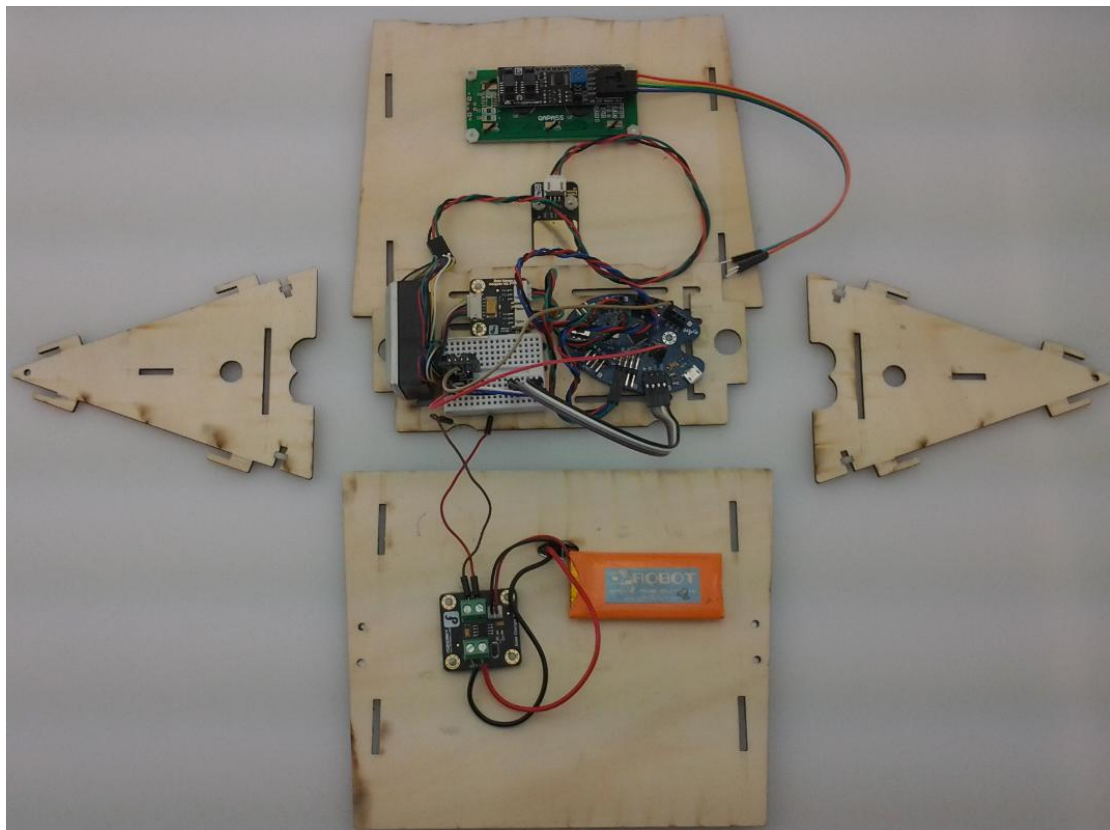

## 使用方法 How to Use

### 1 在使用样例程序的情况下，气象站将：

When using the example program, Weather Station will:

- ✓ 以每天的 20:00 点作为气象测量一天的结束时间  
Weather monitoring would end at 20:00 each day
- ✓ 每小时采集一次数据，并自动保存  
One data collection per hour with automotive record keeping of the data
- ✓ 可以保存两天的数据（今天和昨天）  
Data would be stored for two days once collected (the day it's collected and the next day)
- ✓ 当阳光充足时将自动为锂电池充电  
Automatically charge the lithium battery when covered with abundant sunshine
- ✓ 在没有充足阳光的情况下，待机为 15 天左右时间  
It offers 15 days' standby time without abundant sunshine
- ✓ 当触摸前面板上的触摸区时，液晶屏将显示测量信息  
When you tap the touchable area within the front plate, information monitored will be displayed on the LCD screen

### 2 推荐使用模式

We recommend you the following two ways to use it.

#### 1) 模式一：学生、儿童的气象统计科学活动

Way One: For students & kids to collect weather data

- ✓ 将气象站放在阳台上，太阳板朝向太阳中午的方向  
Put the weather station on the balcony. The solar panel shall face where the sun is at soon
- ✓ 将 record\_chart.doc 记录表打印  
Print the record\_chart.doc
- ✓ 每天 20:00 后将当天统计的气象信息记录在记录表中  
Type the weather data collected each day into the weather statistics record sheet
- ✓ 每周分析一下天气特点，曲线规律。  
Analyze features of the weather conditions each week and draw a curve graph to show the features

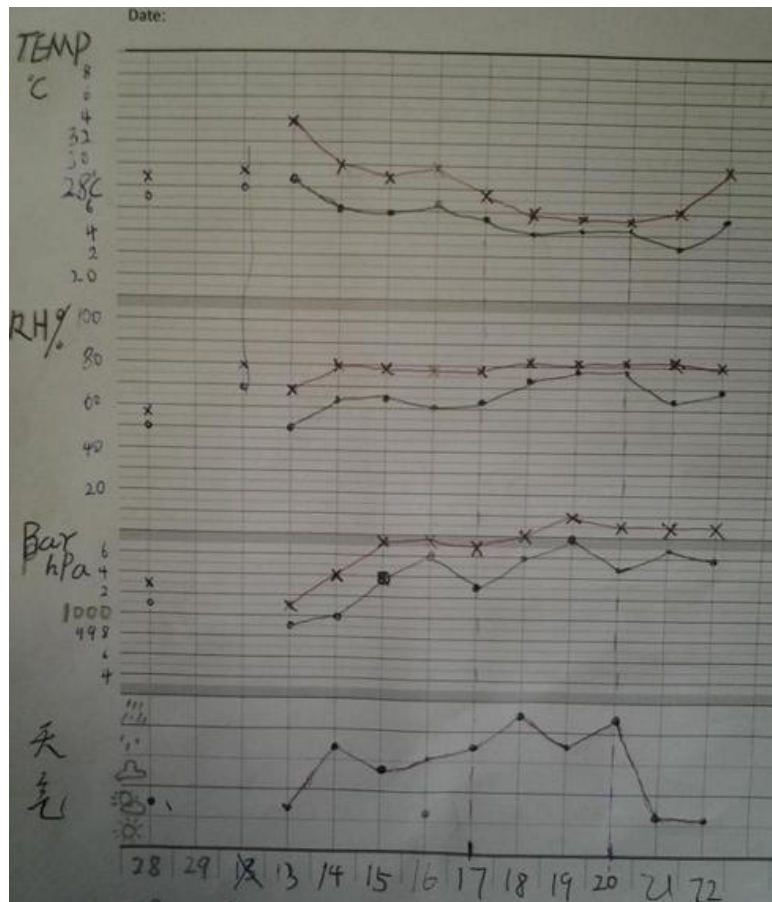

## 2) 模式二：Maker 制作

Way Two: Maker

如何用由你决定。

About the way to use it, it's all up to you.